

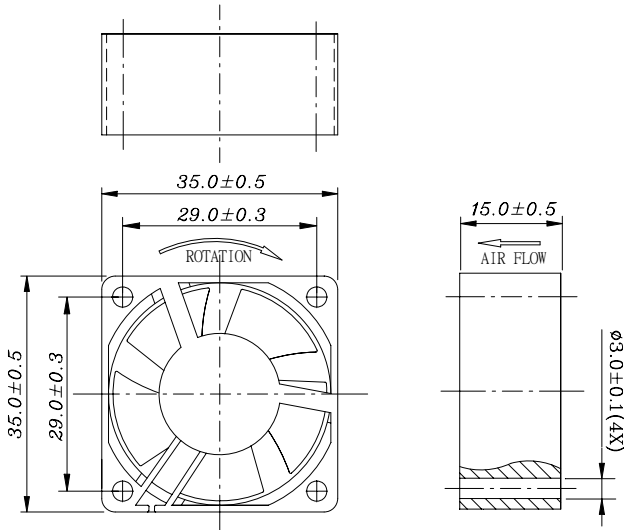
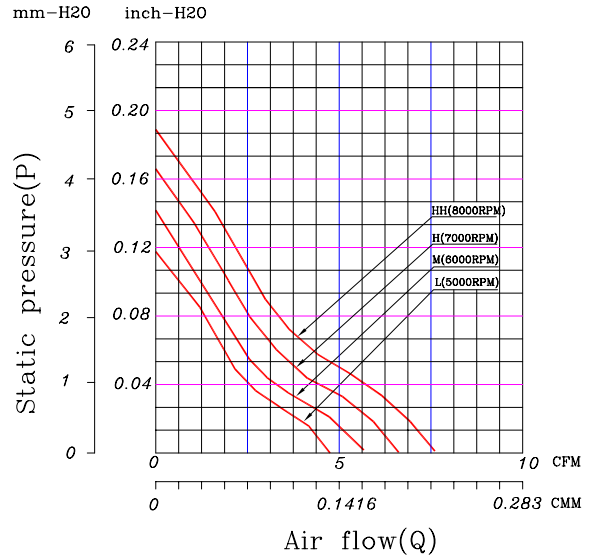

**35 x 35 x 15 mm Series**
**5VCD**
**Dimensions**

**Performance Curves**

Air exhaust over struts. Rotational direction CCW looking at rotor.

Brushless DC Motor	Bearing Type
Housing: PBT 94V0	● CeraDyna A
Impeller: PBT 94V0	● CeraDyna C
Weight: 14 g	○ 2-Ball
Impedance protected	○ 1-Ball-1-Sleeve
Lead wire UL 1095 AWG 28	● Sleeve

Function options	
● Frequency Generator	● Auto Restart
○ Temperature Control	○ Rotation Detection
○ PWM Control	

\* Safety Approval: CE, UL, TUV

\* All fans are with electronic protection against reverse polarity. The fan only operates when the polarity is correct.

**Specifications**

Model	Rated Voltage (VDC)	Rated Current (Amp)	Input Power (Watts)	Nominal Speed (RPM)	Airflow (CFM)	Static Pressure (inch-H <sub>2</sub> O)	Noise Level (dBA)
FD0535-A00XXC	5	0.28	1.40	8000	7.60	0.19	30.00
FD0535-A10XXC	5	0.22	1.10	7000	6.65	0.16	26.00
FD0535-A20XXC	5	0.17	0.85	6000	5.70	0.14	23.00
FD0535-A30XXC	5	0.12	0.60	5000	4.75	0.12	20.00

\* All readings are typical value at rated voltage.

 \* Please refer to **PART NUMBER SYSTEM** for bearing type and part number "XX" designation.

\* Specifications are subject to change without prior notice.

\* Please specify revision number when ordering.